



# 湖州恒鑫过滤科技有限公司

Huzhou Hengxin Filter Technology Co.,ltd

2020 (第十三期)



湖州恒鑫过滤科技有限公司成立于一九九五年，是国内专业的水处理配件生产商，拥有各种国家专利四十余项，产品已出口美国、澳洲、欧洲、中东、台湾等多个国家和地区。

产品主要包括爪型布水器、玻璃钢罐体配件、水帽、盐阀及其配件，和具有自主知识产权的全塑精密过滤器（3芯/5芯/8芯/9芯）系列，全塑袋式过滤器（1#，2#）系列，玻璃钢精密过滤器（18芯）系列，大通量PALL款过滤器系列，TBF<sup>®</sup>管式可反洗过滤组件，大流量滤芯过滤器系统组合，以及具有大通量、高流速、高强度等优良性能的绕丝管布水器系列。

“以质量求生存，以诚信赢客户，以优新取市场”是恒鑫公司的创业宗旨。公司热忱欢迎您的光临和惠顾，期待您时刻关注我们的企业和产品。

Huzhou Hengxin Filter Technology Co.,Ltd was found in 1995, is the professional manufacturer of water treatment products, have got more than 40 patent certifications. The Products have been exporting to America, Australia, Europe, Middle-east countries.

The main products including:water distributors,accessories of FRP tanks, filter nozzles,and UPVC cartridge filter housing (3/5/8/9 rounds) series, UPVC bag filter housing (1#/2#) series, FRP cartridge filter housing (18rounds) series. Pall filter housings, TBF<sup>®</sup> tubular Backwashing filters, High Flow Purification Systems,and high flow pvc sonic-welded screen water distributors.

With our good quality, profession & innovation products, excellent service, we warmly welcome your presence and patronage.



# 布水管, 水帽, 布水器, 罐体配件, 盐阀, 盐箱系列

Filter Nozzle Arms, Filter Nozzles, Distributors, FRP Tank Accessories, Brine value and brine tank

- ◎ 布水管系列  
Filter Nozzle Arms
- ◎ 水帽系列  
Filter Nozzles
- ◎ 布水器系列  
Distributors
- ◎ 罐体配件系列  
FRP Tank Accessories
- ◎ 盐阀, 盐箱系列  
Brine value and brine tank
- ◎ 流量计系列  
Flowmeters series



所有布水器产品, 如果在酸碱浓度较高的环境下使用, 购买前请咨询本公司。

Please consult with us first if the distribution which you purchase if used in a high concentration of acid and base environment.

# 专业 创新

## PROFESSION & INNOVATION



Type: H53-1, H53-2, H53-3

Type: H85

Type: H135

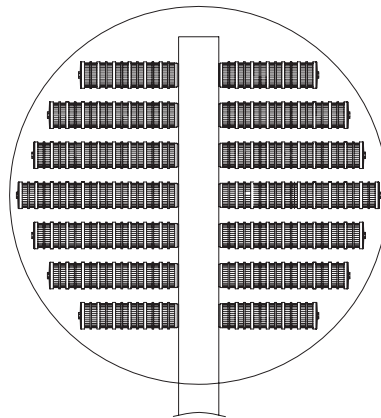
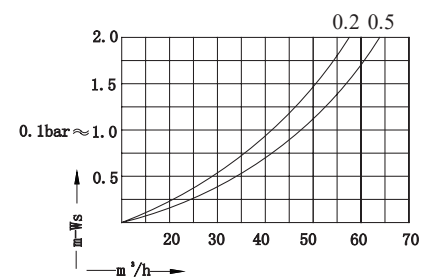
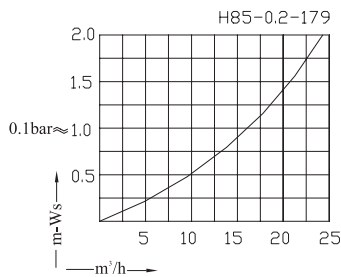
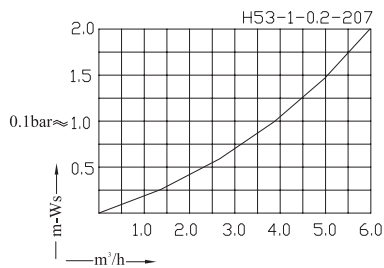
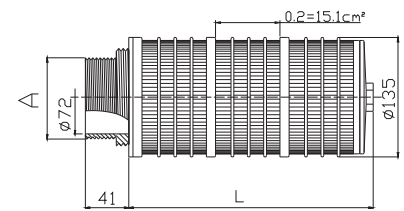
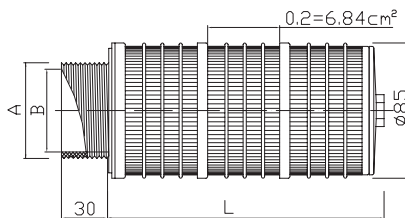
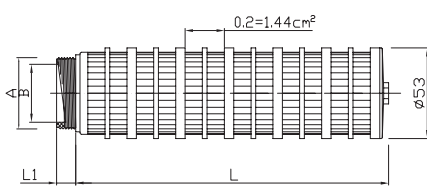
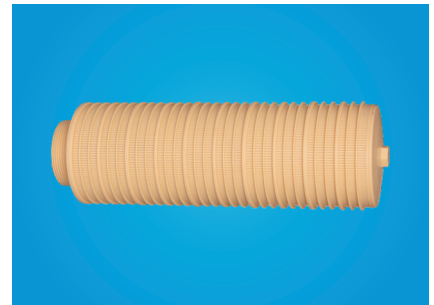
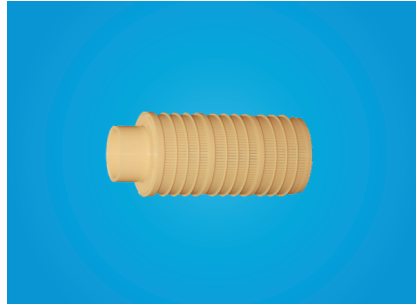

- V42
- V60
- V80
- V100
- H53
- H85
- H135

型号 (Type)	A(mm)	B(mm)	L1(mm)	缝隙Slots(mm)	材质Material	L2(mm)
H53-1	1/4"G	21	22	0.2/0.5	PP PPGV30S PVDF	207,271,303,335,+32...
H53-2	1"NPT/1"G	21	17			111,175,207,239, +32...
H53-3	3/4"NPT	18.5	17			111,175,207,239, +32...
H85	2"PT/2"NPT/2"G	50	30			73,126,179,232,285,+53...
	1.5"NPT/1.5"G	37	30			
H135	3"NPT/ 3"BSPT	72	41	PP/PVDF	173,248,323,398,473,+75..	

PVC全焊式绕丝筛管可广泛应用于油、气、水井防沙，化工，环保工业中，其在水处理工业中的地位尤其突出，是各类水资源及收集树脂过滤筛管中应用最广泛的一种。

PVC Sonic-welded screens can be widely used in the oil,gas,water wells sand prevention, chemical,environmental industries, the position in the water treatment industry is particular highlight.

**产品优势:**

- 1、该筛管由改性PVC材料研制而成，具有高强度，高韧性，耐酸碱，抗腐蚀等优点。
- 2、梯形丝持续绕组在呈圆周式排列的支撑杆上形成持续的高密度均匀缝隙，保证了筛管的开口面积百分比和无堵塞性，避免了沉淀物的高密度堆积造成的阻塞，从而为提高生产效率或延长设备的使用寿命提供了保证。
- 3、Vee字形开口的设计形式保证了液体过滤的顺畅性。
- 4、绕丝与所有纵向支撑杆之间均通过焊接组合，使整根筛管形成不可分割的整体，结实耐用，工作寿命周期更长久。
- 5、根据实际需求设计的纵向支撑杆排列，及筛管的连续性缝隙形式，使得该产品具备更高的抗压性能。
- 6、该成品的各项优秀性能提高了设备的过滤效率和使用周期，使得该产品成为液体过滤设备中佼佼者。

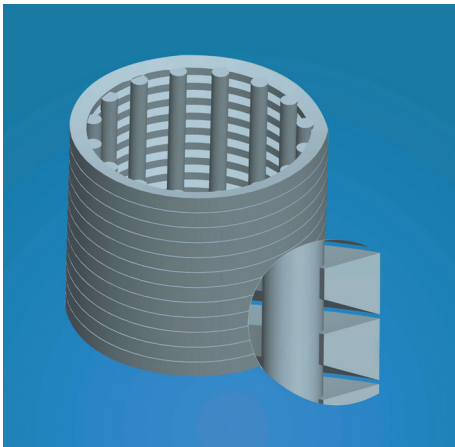

**Product Merits:**

1. UPVC Sonic-welded screen has good corrosion resistant from salts and gases commonly found in either salt or fresh water, more economical than metal screens.
2. The wedge wire wind around the cylindrical rod forms continuous, high-density uniform Vee shaped gaps, ensure the open area without blockage, and can avoid the accumulation of sediment caused by blocking high-density, so as to increase productivity or guarantee to extend the life of equipment.
3. The design of the Vee shaped gap ensures the liquid can be filter unobstructed.
4. The wedge wire and all the vertical rods are connected by sonic-weld. It's strong, durable, and has longer working life.
5. The design of the vertical rod arrangement can be changed according to the actual requirements; combine the continuous screen, making the product has a higher compression performance.
6. Its excellent performance improves the equipment's filter efficiency and the life cycle, makes it to become the leader in liquid equipment

型号	外径 O. D.	内径 I. D.	连接方式 Connect	缝隙 Slots (mm)	长度
V42	42mm	30mm	G3/4" / G1" / NPT1"	0.15/0.2/0.25/	自选 Optional
V60	60mm	46mm	G2" / NPT2"	0.3/0.35/0.4/	
V80	80mm	66mm	G3" / NPT3"	0.45/0.5/.....	
V100	100mm	86mm	G4" / NPT4"	任意缝隙可选	

本产品已获两项国家发明专利 专利号为:200710169538.8 和 200710164499.X

The product has got 2 patent certifications. The patent No.: 200710169538.8 200710164499.X

Type:H1201-A



材质 (Material) : PP/PVDF  
 缝隙 (Slots) : 0.2mm

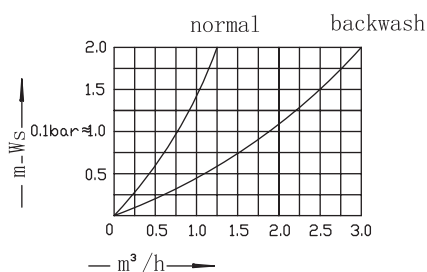

Type:H1201-B



材质 (Material) : PP  
 缝隙 (Slots) : 0.2mm

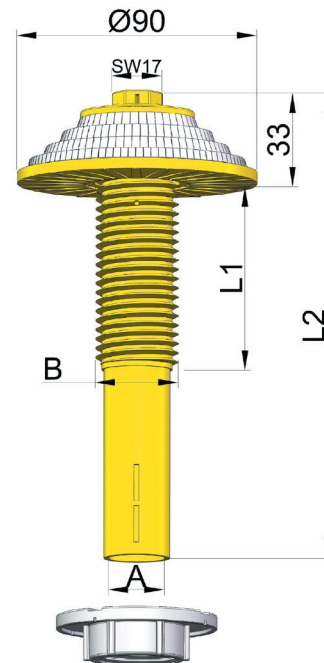
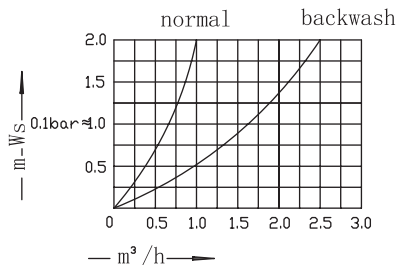

型号 (Type)	内径 A(mm)	外径 B(mm)	L1(mm)	L2(mm)
H1201-A	22	1¼WW	62	174
H1201-B	16	M24	62	174

注：用于砂滤器、双层滤器、多介质滤器、活性炭滤器等，内有调节流量球，如无需调节流量球，采购时请备注

Type: H1208



材质 (Material) : PP  
 缝隙 (Slots) : 0.2mm

Type: H1208-1



材质 (Material) : PP  
 缝隙 (Slots) : 0.2mm

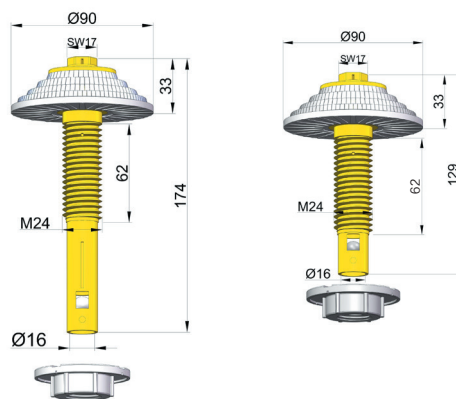

① backwash ② normal

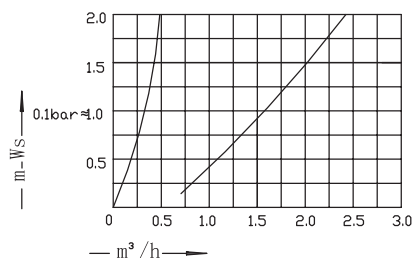

型号 (Type)	内径 A(mm)	外径 B(mm)	L1(mm)	L2(mm)
H1208	16	M24	62	174
H1208-1	16	M24	62	129

注：用于软水器、阳床、阴床和混床，内有调节流量球，如无需调节流量球，采购时请备注

Type: H1202



材质 (Material) : PP/PVDF  
 缝隙 (Slots) : 0.2/0.35mm

Type: H1202-1



材质 (Material) : PP/PVDF  
 缝隙 (Slots) : 0.2/0.35mm

Type: H1202-3



材质 (Material) : PP/PVDF  
 缝隙 (Slots) : 0.2/0.35mm

Type: H1202-4



材质 (Material) : PP/PVDF  
 缝隙 (Slots) : 0.2/0.35mm

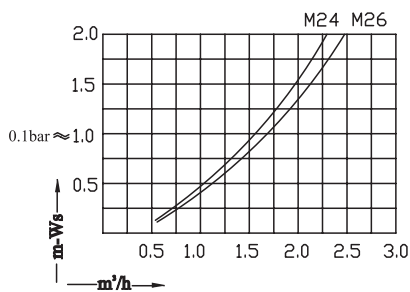
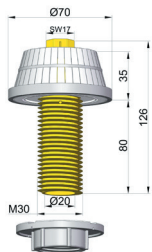
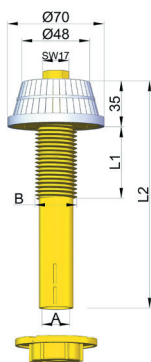

型号 (Type)	内径 A(mm)	外径 B(mm)	L1(mm)	L2(mm)
H1202	18/20	M24/M26	50	120
H1202-1	18/20	M24/M26	50	175
H1202-3	20	1¼WW	63	175
H1202-4	20	1¼WW	80	126

Type: H1201-C



材质 (Material) : PP  
 缝隙 (Slots) : 0.2mm

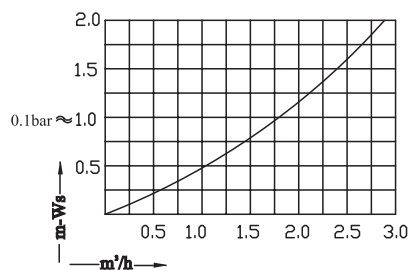

Type: H1203



材质 (Material) : ABS  
 缝隙 (Slots) : 0.3mm

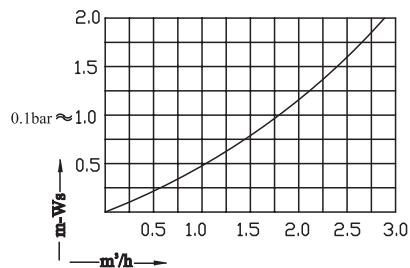
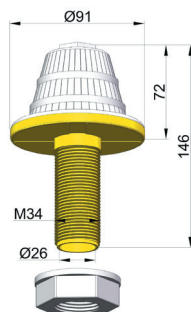

Type:H1205



材质 (Material) : PP  
 缝隙 (Slots) : 0.2/0.5mm

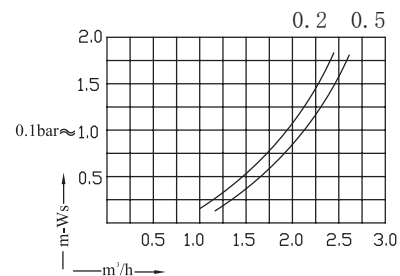
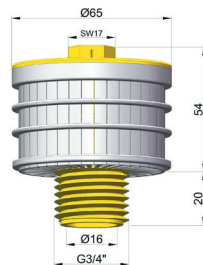

Type: H1206-A



材质 (Material): PP  
 缝隙 (Slots): 0.2/0.5mm

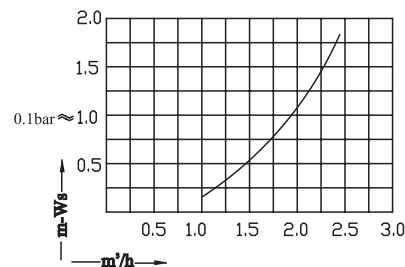
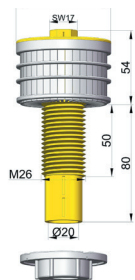

Type:H1206-B



材质 (Material) : PP  
 缝隙 (Slots) : 0.2/0.5mm

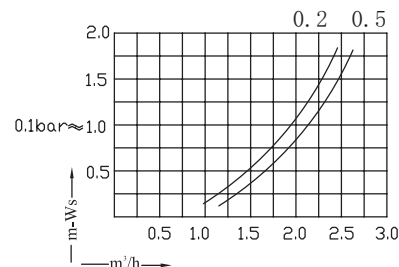
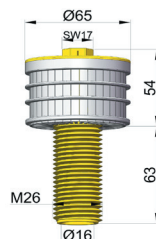

Type: H1206-B2



材质 (Material): PP  
 缝隙 (Slots): 0.2/0.5mm

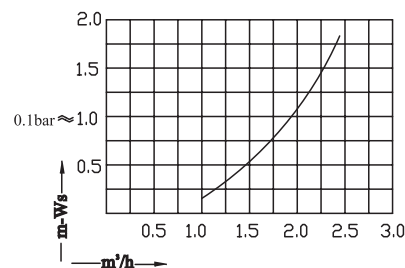
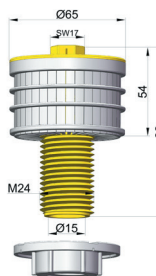

Type: H1206-E



材质 (Material): PP  
 缝隙 (Slots): 0.2/0.5mm

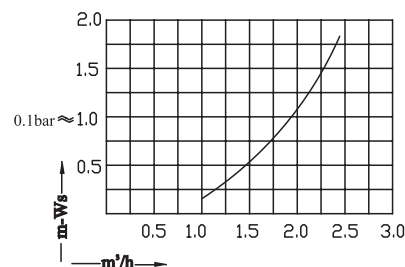
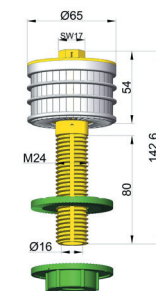

Type: H1207



材质 (Material): ABS  
 缝隙 (Slots): 0.2mm

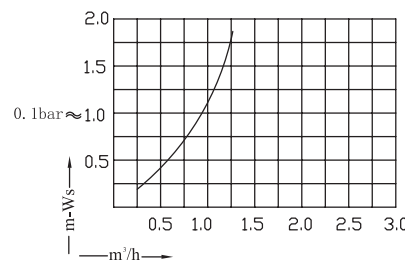
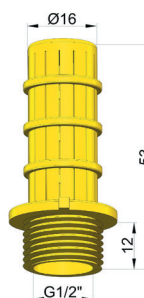



### H1209-A



材质 (Material) : PP  
 缝隙 (Slots) : 0.2/0.5mm

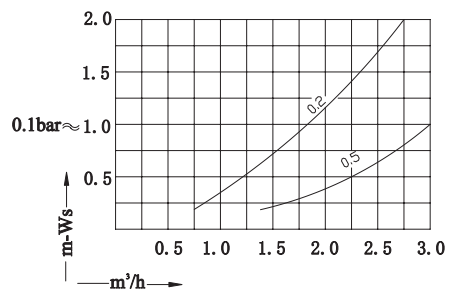
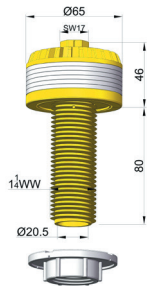

### H1209-B



材质 (Material) : PP  
 缝隙 (Slots) : 0.2/0.5mm

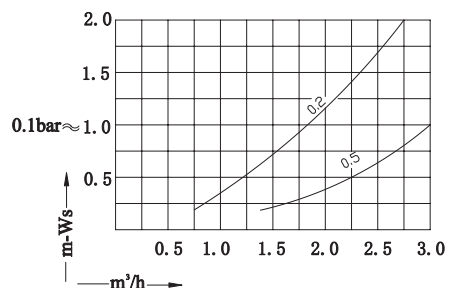

### H1209-AL



材质 (Material) : PP  
 缝隙 (Slots) : 0.2/0.5mm

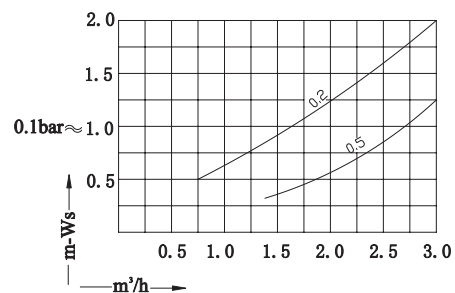
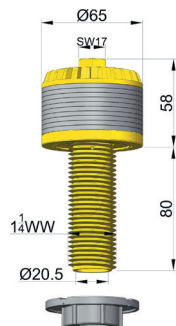

### H1209-BL



材质 (Material) : PP/PPGV30S/PVDF  
 缝隙 (Slots) : 0.2/0.5mm

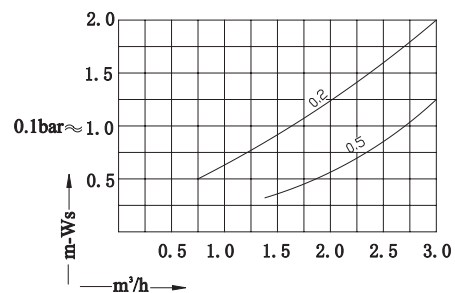
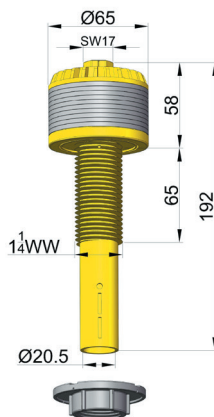

### H1202-K



材质 (Material) : PP  
 缝隙 (Slots) : 0.2/0.35mm

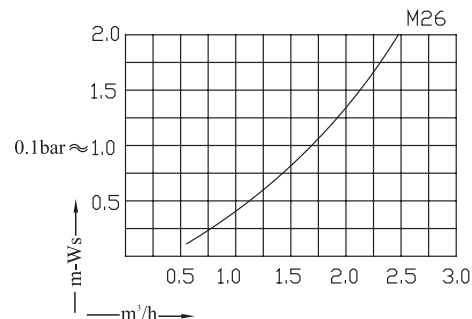
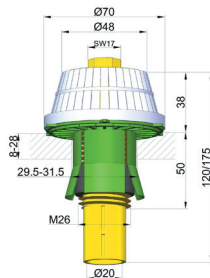

### H1202-G



材质 (Material) : PP  
 缝隙 (Slots) : 0.2/0.35mm

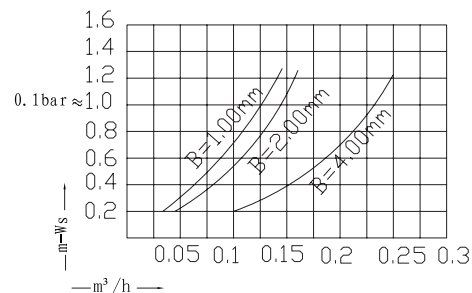
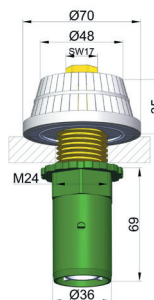

### H1206-K



材质 (Material) : PP  
 缝隙 (Slots) : 0.2/0.5mm

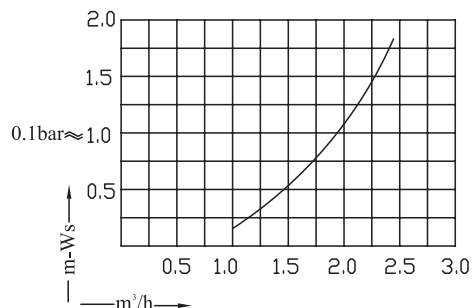
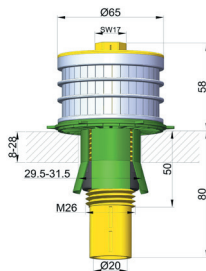

### H1206-G



材质 (Material) : PP  
 缝隙 (Slots) : 0.2/0.5mm

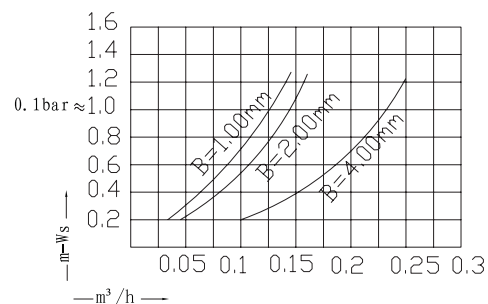
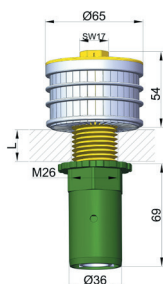

### Type: H1204-A



$20 \leq L \leq 60$

材质 (Material) : PP  
 缝隙 (Slots) : 0.2/0.5mm

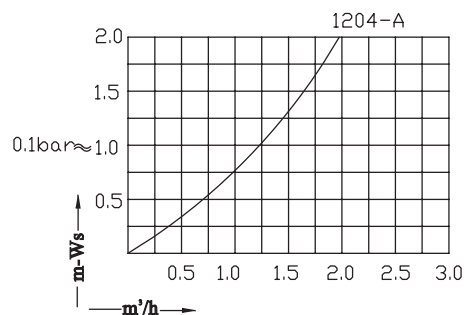
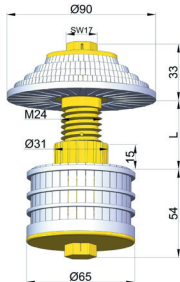

### Type: H1204-B



$15 \leq L \leq 60$

材质 (Material) : ABS  
 缝隙 (Slots) : 0.3mm

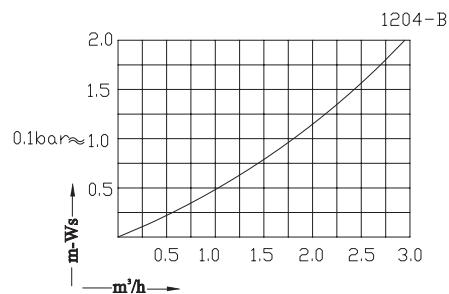
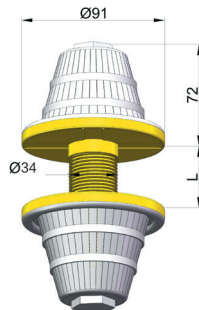

### H1204-C



$15 \leq L \leq 50$

材质 (Material) : PP  
 缝隙 (Slots) : 0.2/0.5mm

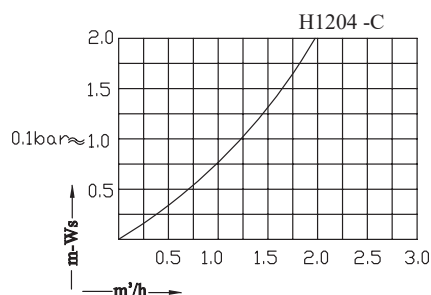
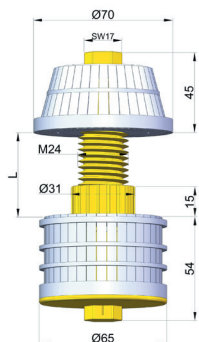

### H1204-D



$20 \leq L \leq 60$

材质 (Material) : PP/PPGV30S/PVDF  
 缝隙 (Slots) : 0.2/0.5mm

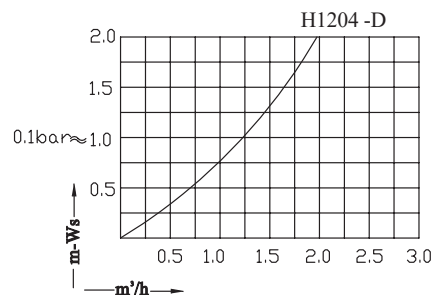
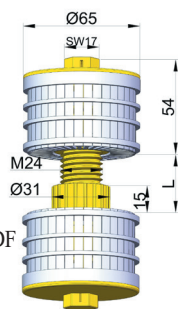

### H1204-E



材质 (Material) : PP/PPGV30S/PVDF  
 缝隙 (Slots) : 0.2/0.5mm

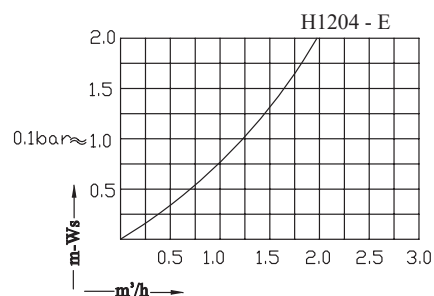
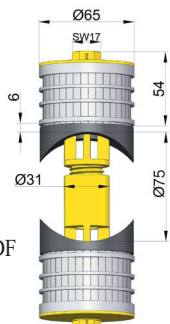

Type:H1206-C

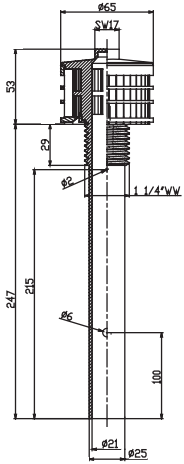

材质(material): PP

缝隙(slots):0.2mm=197.6mm<sup>2</sup>

0.5mm=494mm<sup>2</sup>

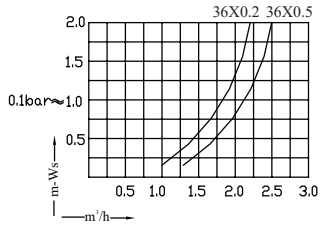

Type:H1206-D

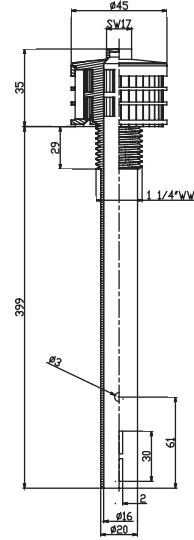

材质(material): PP

缝隙(slots):0.25mm=187.5mm<sup>2</sup>

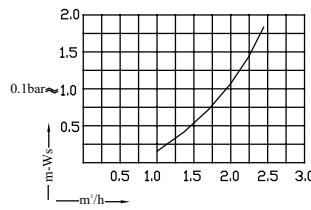

Type:H1202-2

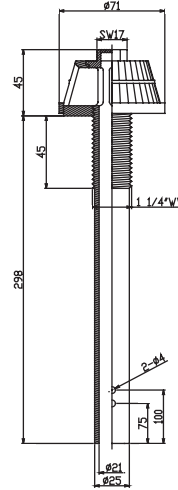

材质(material): PP

缝隙(slots):0.2mm=254.8mm<sup>2</sup>

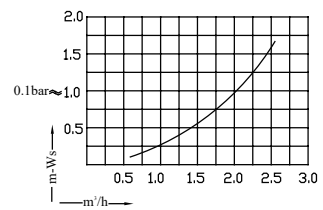

Type:A

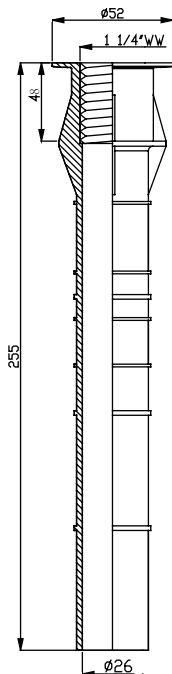

Type:B

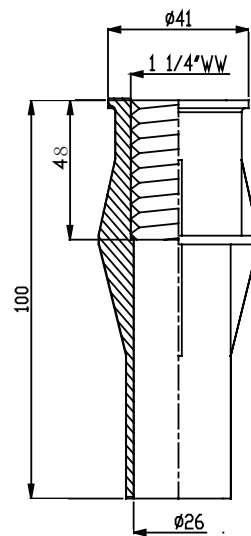

# 布水器系列

## Water Distributor Series

◎ 普通组件式布水器  
Normal assembled water distributor

◎ 大通量 高流速 高强度 绕丝管布水器  
High-flow pvc sonic-welded screen water distributor



### 阿图祖上下集散

Autotrol top and bottom distributor

H2801-B (3/4")

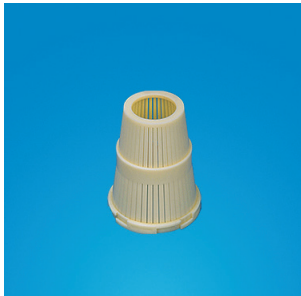

材质 (Material): ABS  
缝隙 (Slots): 0.25mm

H2803 (3/4")



材质 (Material): ABS  
缝隙 (Slots): 0.25mm

### 富来克上下集散

Fleck top and bottom distributor

H2805 (3/4")



材质 (Material): ABS/PVC  
缝隙 (Slots): 0.25mm

H2807 (3/4")



材质 (Material): ABS/PVC  
缝隙 (Slots): 0.25mm

### 普通上下集散

1" top and bottom distributor

H2805-1(1")



材质 (Material): ABS  
缝隙 (Slots): 0.25mm  
中心管 (Tube)  
1": (32mm/33.4mm)

H2807-1(1")



材质 (Material): ABS  
缝隙 (Slots): 0.25mm  
中心管 (Tube)  
1": (32mm/33.4mm)

### 香菇头及加长香菇头系列 Distributor for 6"-12" Vessels

H2809A H2809B

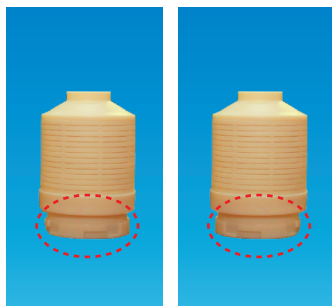

材质 (Material): ABS/PP  
缝隙 (Slots): 0.25mm  
中心管 (Tube)  
3/4": (26.7mm)  
1": (32mm/33.4mm)

H2810



材质 (Material): ABS/PP  
缝隙 (Slots): 0.25mm  
中心管 (Tube)  
3/4": (26.7mm)  
1": (32mm/33.4mm)

H2809AL H2809BL

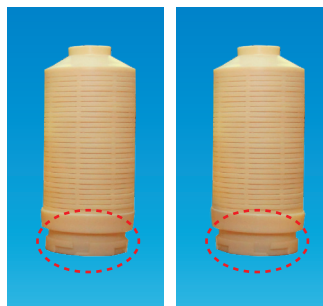

材质 (Material): ABS/PP  
缝隙 (Slots): 0.25mm  
中心管 (Tube)  
3/4": (26.7mm)  
1": (32mm/33.4mm)

H2810L



材质 (Material): ABS/PP  
缝隙 (Slots): 0.25mm  
中心管 (Tube)  
3/4": (26.7mm)  
1": (32mm/33.4mm)

普通上布水器 中心管1¼ /1.5" (42/48.3/50mm) 缝隙Slots: 0.2/0.5/0.8mm

1¼ / 1.5" top distributor

H182A

配Fleck阀 suit for Fleck valve

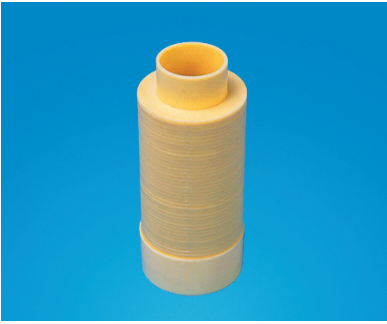

H182B

配润新阀 suit for Runxin valve



H182-1

配阿图祖麦能阀 suit for Autotrol Nylon valve



富来克3150上布水器 中心管2" (60.3/63mm)

top screen for fleck 3150 valve

H182AL-1(2")



有不锈钢螺钉 with stainless screw

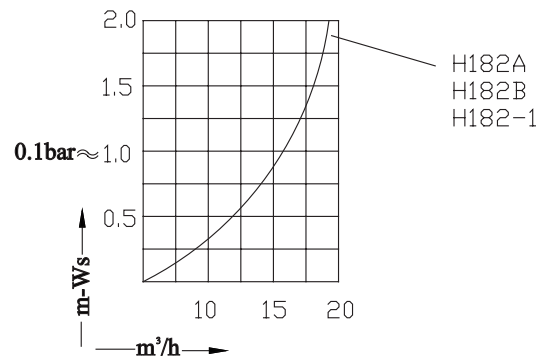

润新阀用上布水器

top screen for Runxin valve

H182BL-1

中心管1.5"(48.3/50mm)



Thread

H182BL-2

中心管2"(60/60.3mm)



Thread

有不锈钢螺钉 with stainless screw

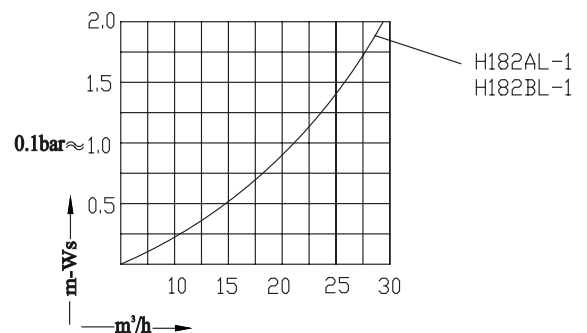

Type: H2804



材质 (Material): PP  
 缝隙 (Slots): 0.2mm  
 插管口 (øA):  
 H2804: 50mm/48.3mm  
 无不锈钢螺钉, 耐腐蚀  
 without SS screw

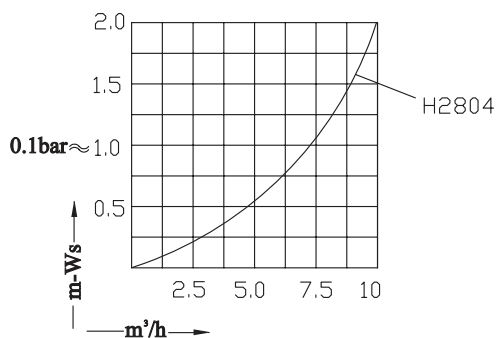
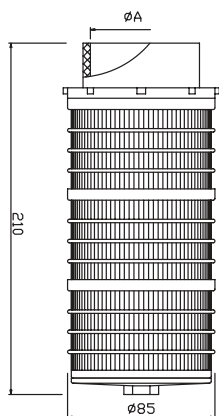

Type: H2808



材质 (Material): ABS  
 缝隙 (Slots): 0.25/0.5/0.8mm  
 插管口 (øA):  
 H2808/H2808L1/H2808L2:  
 50mm/48.3mm/42mm

Type: H2808L1



Type: H2808L2

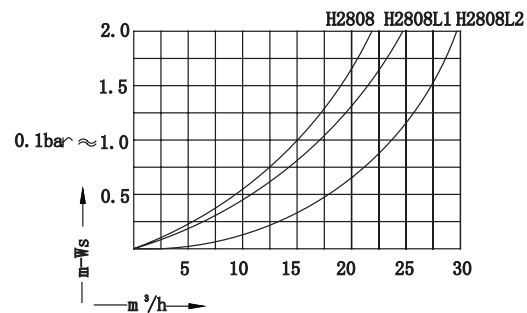
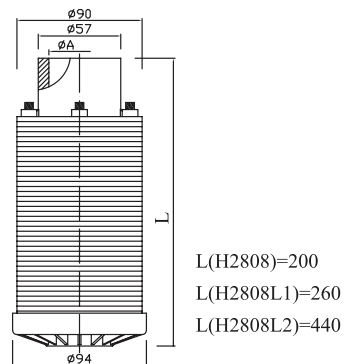



### H2813N



材质 (Material) : PP  
 缝隙 (Slots) : 0.2/0.5mm

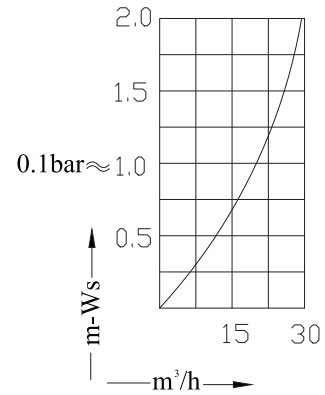
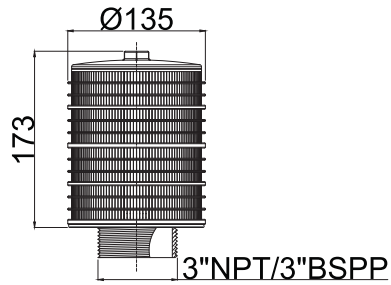

### H2814N



材质 (Material) : PP  
 缝隙 (Slots) : 0.2/0.5mm

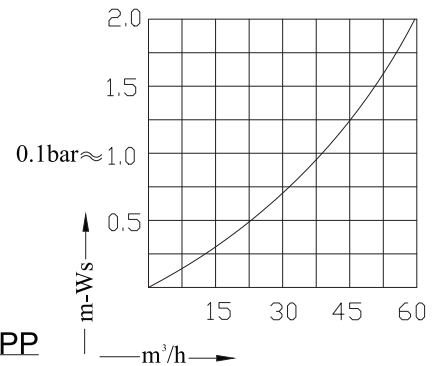
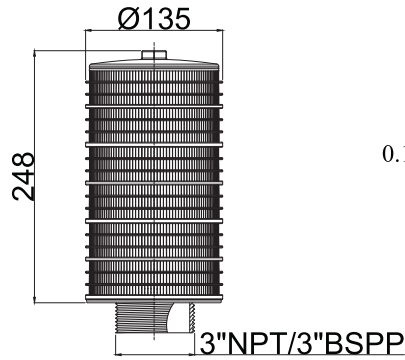

### H2815N



材质 (Material) : PP  
 缝隙 (Slots) : 0.2/0.5mm

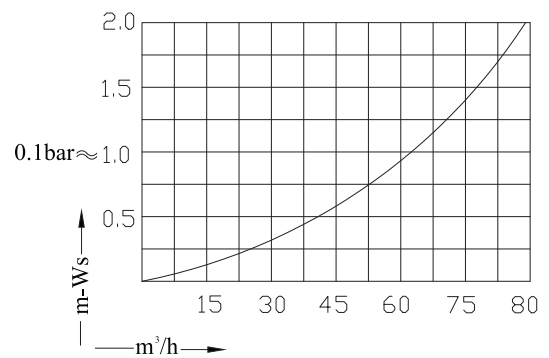
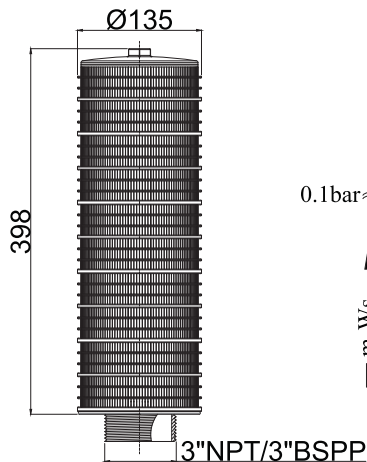

A series

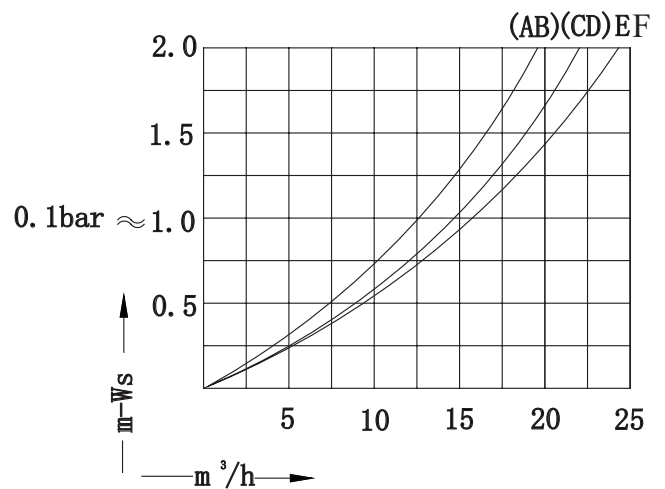
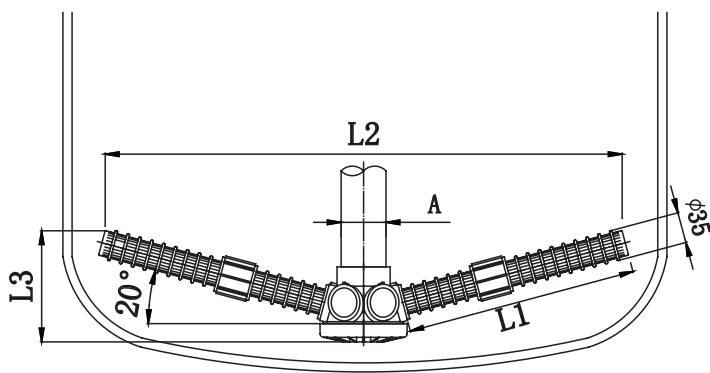
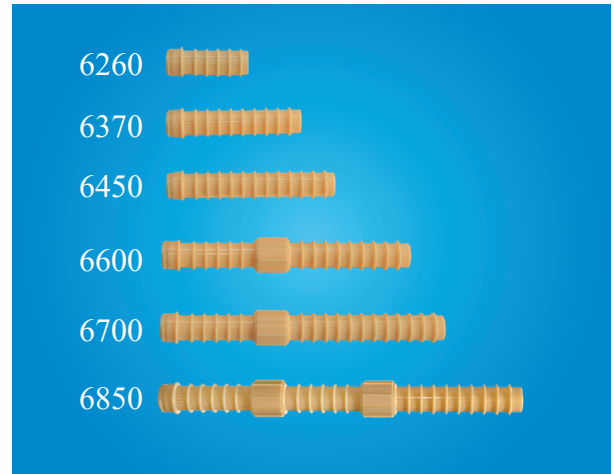
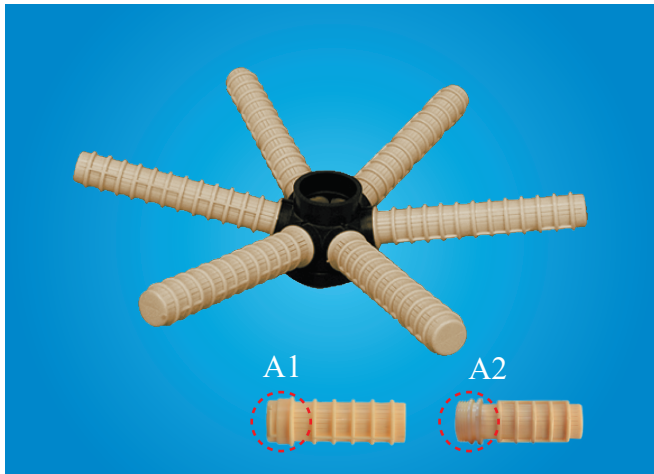

型号 Type		尺寸 Dimension(mm)				罐体尺寸 Tank Size Inches(mm)	流量 Flow	罐体上开口 Top Opening
		A	L1	L2	L3			
HU6260A1	HU6260A2	42/48.3/50	82	145	71	12-16" (300-400mm)	A	4"-8UN
HU6370A1	HU6370A2		142	365	83	18-21" (450-550mm)	B	
HU6450A1	HU6450A2		182	440	95	24" (600mm)	C	
HU6600A1	HU6600A2		266	610	105	30" (750mm)	D	
HU6700A1	HU6700A2		308	690	114	36-42" (900-1000mm)	E	
HU6850A1	HU6850A2		400	870	142	40-48" (1000-1200mm)	F	

Note:

A1系列支管采用卡口式, A2系列支管采用螺纹式。

The laterals: A1=quick lock A2=thread



B series

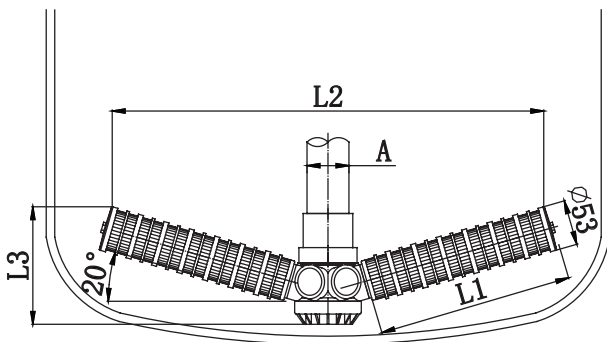
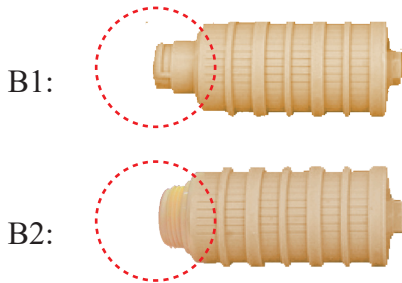
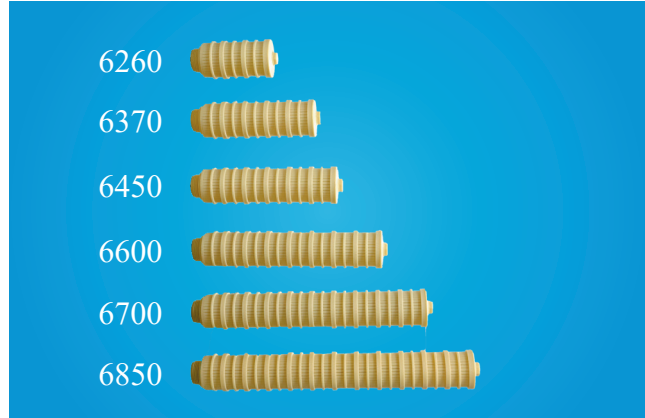

SLOT:0.2mm/0.25mm

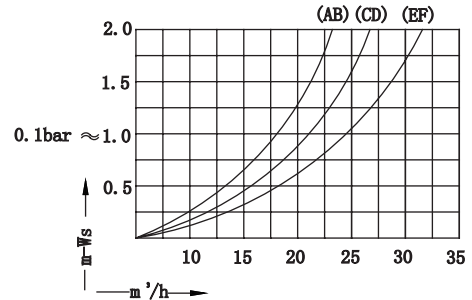

SLOT:0.4/0.5/0.8mm

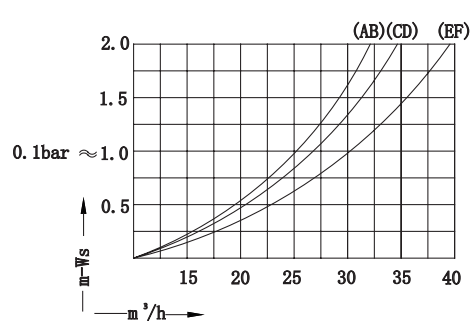

型号 Type		尺寸 Dimension (mm)				罐体尺寸 Tank Size	流量 Flow	罐体上开口 Top Opening
		A	L1	L2	L3	Inches (mm)		
HU6260B1	HU6260B2	1.5" (42/48.5/50)	111	296	110	12-16" (300-400mm)	A	4"-8UN
HU6370B1	HU6370B2		174	416	125	18-21" (450-550mm)	B	
HU6450B1	HU6450B2		205	455	135	24" (600mm)	C	
HU6600B1	HU6600B2		268	575	165	30" (750mm)	D	
HU6700B1	HU6700B2	2" (60/63)	331	710	175	36" (900mm)	E	
HU6850B1	HU6850B2		394	835	185	40-48" (1000-1200mm)	F	

Note:

B1系列支管采用卡口式，B2系列支管采用螺纹式。

The laterals: B1=quick lock B2=thread

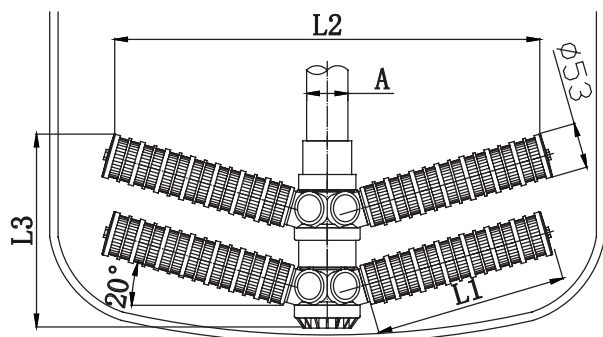
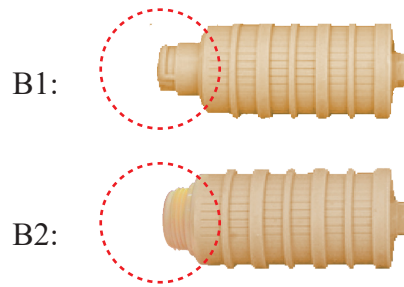
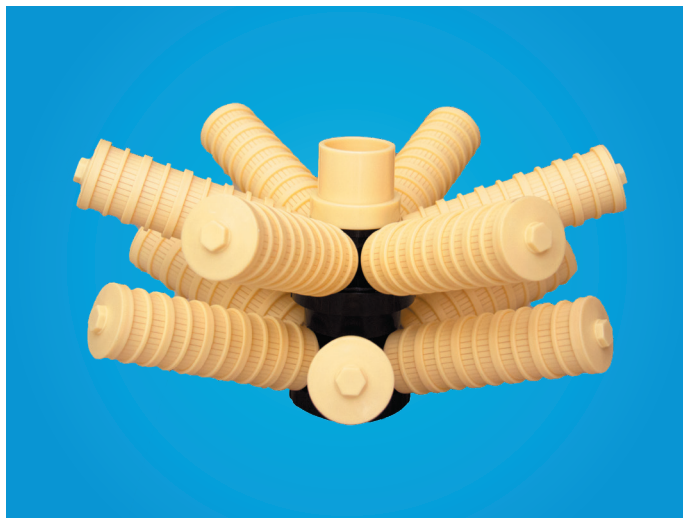

SLOT:0.2mm/0.25mm

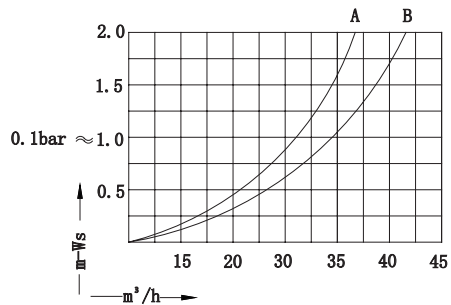

SLOT:0.4/0.5/0.8mm

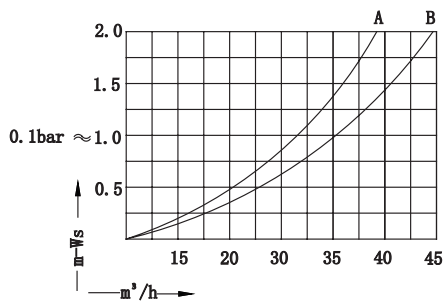

型号 Type	尺寸 Dimension (mm)				罐体尺寸 Tank Size Inches (mm)	流量 Flow	罐体上开口 Top Opening
	A	L1	L2	L3			
HU6700B1-2	60.3/63	331	710	300	36"-42" (900-1000mm)	A	4"-8UN
HU6850B1-2		394	835	310			

Note:

B1系列支管采用卡口式, B2系列支管采用螺纹式。

The laterals: B1=quick lock B2=thread



H5671BE  
(ELBOW CONNECT)



H5671BS  
(STRAIGHT CONNECT)



H5671BU  
(UNION CONNECT)



H5671BU-V  
(UNION CONNECT)  
带负压保护器 (见P33页)  
with vacuum breaker (refer to P33)



4"罐体接口紧固工具  
Tighten tool for 4" FRPopening

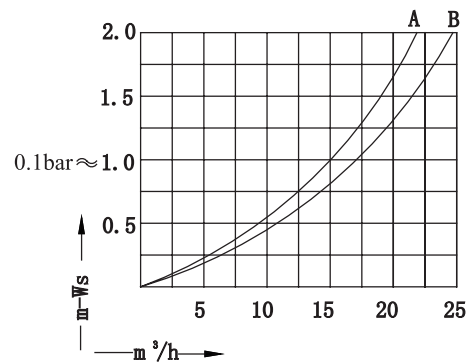
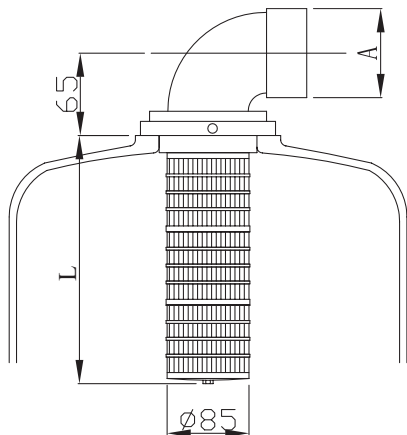

型号 Type	外管连接方式	尺寸 (mm)		罐体尺寸 Tank Size	流量	罐体上开口
	Connect method	A	L	Inches (mm)	Flow	Top Opening
H5671A/H5671B	E: Elbow S: Straight U: Union	60/63	210	12"-36" (300-900mm)	A	4"-8UN
H5671AL/H5671BL			316	36"-48" (900-1200mm)	B	

A系与B系所采用的4"罐口连接件不同  
The 4" adaptor is difference between A series and B series





(ELBOW CONNECT)



(STRAIGHT CONNECT)



(UNION CONNECT)



4"罐体接口紧固工具  
Tighten tool for 4" FRPopening

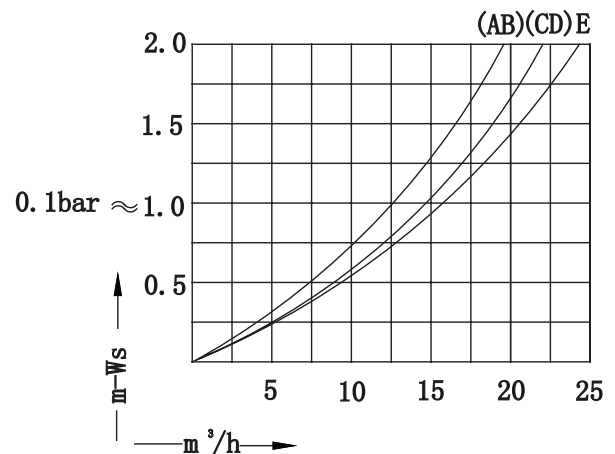
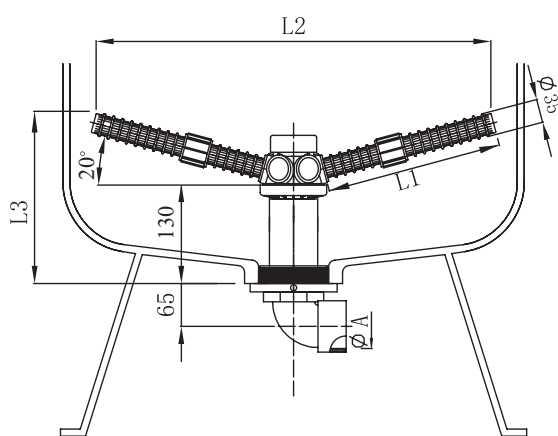

型号 Type		尺寸 Dimension(mm)				罐体尺寸 Tank Size Inches(mm)	流量 Flow	罐体上开口 Top Opening
		A	L1	L2	L3			
HD6260A1	HD6260A2	60/63	82	145	158	12-16" (300-400mm)	A	4" -8UN
HD6370A1	HD6370A2		142	365	172	18-21" (450-550mm)	B	
HD6450A1	HD6450A2		182	440	178	24" (600mm)	C	
HD6600A1	HD6600A2		266	610	198	30" (750mm)	D	
HD6700A1	HD6700A2		308	690	198	36-42" (900-1000mm)	E	
HD6850A1	HD6850A2		400	870	226	40-48" (1000-1200mm)	F	

外管连接方式可选：1、弯头 2、直接 3、活接由令 无特殊说明，默认为弯头连接

Connect Method of Outer Pipe with water distributor: 1,E: Elbow Connect. 2. S: Straight Connect. 3.U: Union Connect.

No special description, would be elbow connect

Note:

A1系列支管采用卡口式，A2系列支管采用螺纹式。

The laterals: A1=quick lock A2=thread



(ELBOW CONNECT)

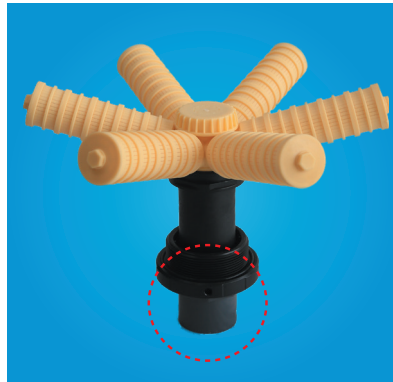

(STRAIGHT CONNECT)



(UNION CONNECT)



4"罐体接口紧固工具  
Tighten tool for 4" FRPopening

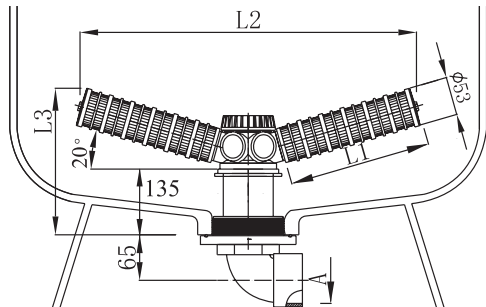

外管连接方式可选：1、弯头 2、直接 3、活接由令  
无特殊说明，默认为弯头连接

Connect Method of Outer Pipe with water distributor: 1,E:  
Elbow Connect. 2. S: Straight Connect. 3.U: Union Connect.  
No special description, would be elbow connect

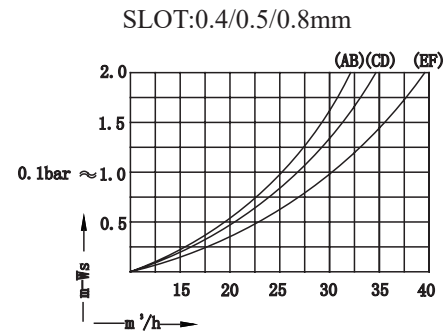
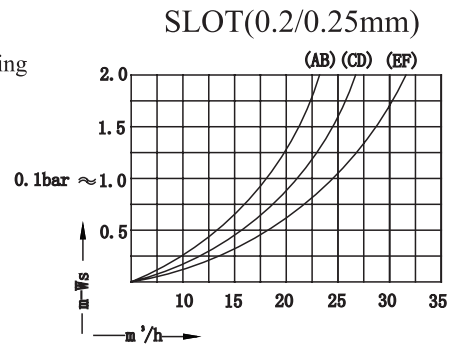

型号 Type		尺寸 Dimension (mm)				罐体尺寸 Tank Size	流量 Flow	罐体下开口 Bottom Opening
		A	L1	L2	L3	Inches (mm)		
HD6260B1	HD6260B2	60/63	111	296	156	12-16" ( 300-400mm)	A	4"-8UN
HD6370B1	HD6370B2		174	416	176	18-21" ( 450-550mm)	B	
HD6450B1	HD6450B2		205	455	186	24" ( 600mm)	C	
HD6600B1	HD6600B2		268	575	203	30" ( 750mm)	D	
HD6700B1	HD6700B2		331	710	223	36" ( 900mm)	E	
HD6850B1	HD6850B2		394	835	233	40"-48" (1000-1200mm)	F	

Note:

B1系列支管采用卡口式，B2系列支管采用螺纹式。

The laterals: B1=quick lock B2=thread



(ELBOW CONNECT)



(STRAIGHT CONNECT)



(UNION CONNECT)

型号 Type		尺寸 Dimension (mm)				罐体尺寸 Tank Size	流量	罐体下开口
		A	L1	L2	L3	Inches (mm)	Flow	Bottom Opening
HD6260B1F	HD6260B2F	60/63	111	296	156	12-16" ( 300-400mm)	A	4"-8UN
HD6370B1F	HD6370B2F		174	416	176	18-21" ( 450-550mm)	B	
HD6450B1F	HD6450B2F		205	455	186	24" ( 600mm)	C	
HD6600B1F	HD6600B2F		268	575	203	30" ( 750mm)	D	
HD6700B1F	HD6700B2F		331	710	223	36" ( 900mm)	E	
HD6850B1F	HD6850B2F		394	835	233	40"-48" (1000-1200mm)	F	



(ELBOW CONNECT)



(STRAIGHT CONNECT)



(UNION CONNECT)

型号 Type		尺寸 Dimension (mm)				罐体尺寸 Tank Size	流量	罐体下开口
		A	L1	L2	L3	Inches (mm)	Flow	Bottom Opening
HD6700B1-2	HD6700B2-2	60/63	331	710	348	36"-40" ( 900-1000mm)	A	4"-8UN
HD6850B1-2	HD6850B2-2		394	835	358	48"-63" (1200-1600mm)	B	

Note:

B1系列支管采用卡口式，B2系列支管采用螺纹式。

The laterals: B1=quick lock B2=thread



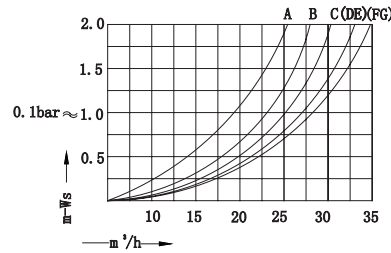
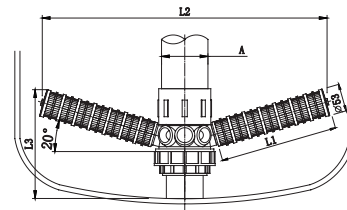

型号 Type	尺寸 Dimension(mm)				罐体尺寸 Tank Size Inches(mm)	流量 Flow	罐体上开口 Top Opening
	A	L1	L2	L3			
HU5669B2-1	60.3/63 89/90	205	490	205	24" (600mm)	A	6" FLG
HU5670B2-1		268	615	225	30" (750mm)	B	
HU5672B2-1		300	690	235	36" (900mm)	C	
HU5673B2-1		363	810	255	42" (1000mm)	D	
HU5674B2-1		426	930	275	48" (1200mm)	E	
HU5675B2-1		489	1050	295	60" (1500mm)	F	
HU5676B2-1		552	1170	305	63-80" (1600-2000mm)	G	

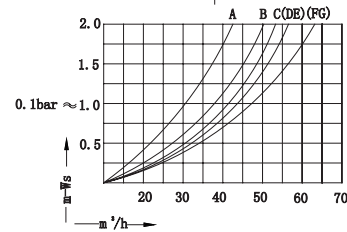
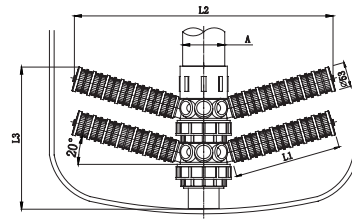

型号 Type	尺寸 Dimension(mm)				罐体尺寸 Tank Size Inches(mm)	流量 Flow	罐体上开口 Top Opening
	A	L1	L2	L3			
HU5669B2-2	89/90	205	490	342	24" (600mm)	A	6" FLG
HU5670B2-2		268	615	352	30" (750mm)	B	
HU5672B2-2		300	690	357	36" (900mm)	C	
HU5673B2-2		363	810	367	42" (1000mm)	D	
HU5674B2-2		426	930	377	48" (1200mm)	E	
HU5675B2-2		489	1050	387	60" (1500mm)	F	
HU5676B2-2		552	1170	407	63-80" (1600-2000mm)	G	

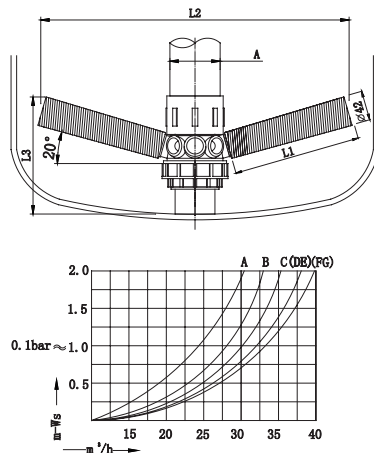

型号 Type	尺寸 Dimension (mm)				罐体尺寸 Tank Size	流量 Flow	绕丝管缝隙 Slot (mm)	罐体上开口 Top Opening
	A	L1	L2	L3	Inches (mm)			
HU5669C-1	89/90	205	490	205	24" (600mm)	A	0.2/0.25/	6"FLG
HU5670C-1		268	615	225	30" (750mm)	B	0.3/0.35/	
HU5672C-1		300	690	235	36" (900mm)	C	0.4/0.45/	
HU5673C-1		363	810	255	42" (1000mm)	D	0.5/	
HU5674C-1		426	930	275	48" (1200mm)	E	.....	
HU5675C-1		489	1050	295	60" (1500mm)	F	任意缝隙可选	
HU5676C-1		552	1170	305	63-80" (1600-2000mm)	G		

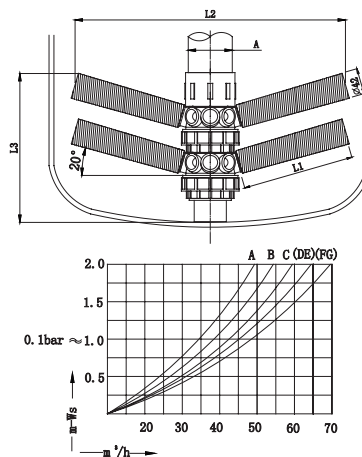

型号 Type	尺寸 Dimension (mm)				罐体尺寸 Tank Size	流量 Flow	绕丝管缝隙 Slot (mm)	罐体上开口 Top Opening
	A	L1	L2	L3	Inches (mm)			
HU5669C-2	89/90	205	490	342	24" (600mm)	A	0.2/0.25/	6"FLG
HU5670C-2		268	615	352	30" (750mm)	B	0.3/0.35/	
HU5672C-2		300	690	357	36" (900mm)	C	0.4/0.45/	
HU5673C-2		363	810	367	42" (1000mm)	D	0.5/	
HU5674C-2		426	930	377	48" (1200mm)	E	.....	
HU5675C-2		489	1050	387	60" (1500mm)	F	任意缝隙可选	
HU5676C-2		552	1170	407	63-80" (1600-2000mm)	G		

## H173



## H173N



无不锈钢螺钉，耐腐蚀  
without SS screw

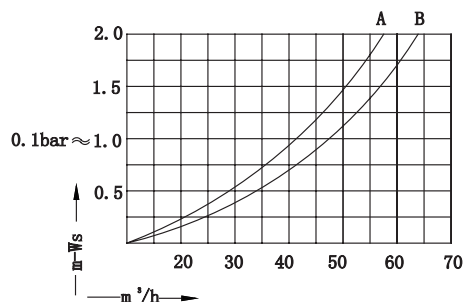
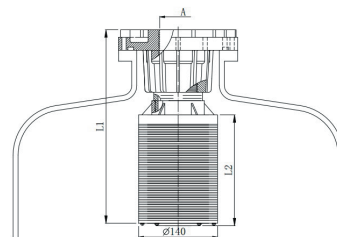

型号 Type	尺寸 Dimension(mm)			罐体尺寸 Tank Size Inches(mm)	流量 Flow	支管缝隙 Slot(mm)	罐体上开口 Top Opening
	A	L1	L2				
H173	89/90/110/114 3" NPT/3" BSPP 4" NPT/4" BSPP 4" UN	360	215	24"-48" (600-1200mm)	A	0.2/0.5	6" FLG
H173L		455	310	48"-80" (1200-2000mm)	B		
H173N		393	248	24"-48" (600-1200mm)	A		
H173NL		543	398	48"-80" (1200-2000mm)	B		

## H176

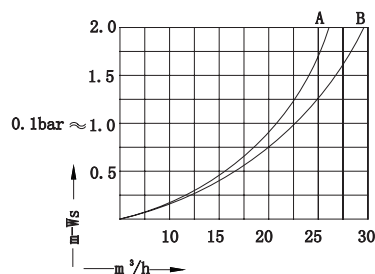
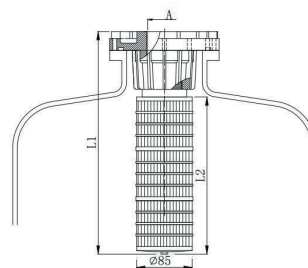

型号 Type	尺寸 Dimension(mm)			罐体尺寸 Tank Size Inches(mm)	流量 Flow	支管缝隙 Slot(mm)	罐体上开口 Top Opening
	A	L1	L2				
H176	89/90/110/114 3" NPT/3" BSPP 4" NPT/4" BSPP 4" UN	325	180	24"-48" (600-1200mm)	A	0.2	6" FLG
H176L-1		430	285	48"-63" (1200-1600mm)	B		

### HD5680

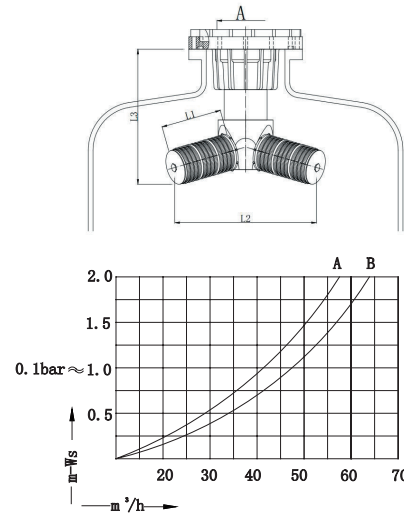

型号 Type	尺寸 Dimension (mm)				罐体尺寸 Tank Size Inches (mm)	流量 Flow	支管缝隙 Slot (mm)	罐体上开口 Top Opening
	A	L1	L2	L3				
HD5680	89/90/110 3"NPT/3"BSPP	180	550	295	36-48" ( 900-1200mm)	A	0.2	6"FLG
HD5680L	4"NPT/4"BSPP 4"UN				286	750		

备注： 流量加大, 法兰开口尺寸请选择4"  
If large flow rate, you'd better choose 4" interface.

### 3900阀用6"法兰式上布水器 top distributor for Fleck 3900

### H171

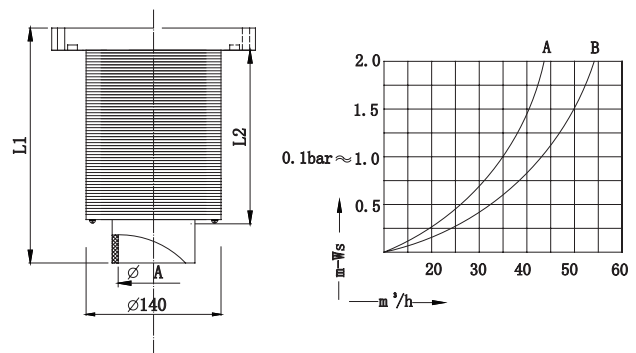

型号 (Type)	尺寸(Dimension) mm			流量 (Flow)	适用罐体 (Tank Size)	罐体开口 (Top Opening)
	A	L1	L2			
H171	90	290	220	A	36"-63"(900-1600mm)	6"FLG
H171L	90	510	440	B	63"-80"(1600-2000mm)	6"FLG

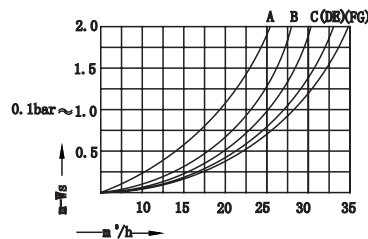
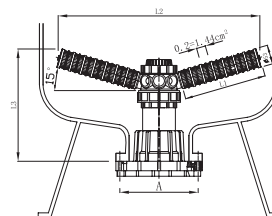

型号 Type	尺寸 Dimension(mm)				罐体尺寸 Tank Size Inches(mm)	流量 Flow	罐体上开口 Top Opening
	A	L1	L2	L3			
HD5669B2-1	89/90/110 /114 3" NPT/3" BSPT 4" NPT/4" BSPT 4" UN	205	490	320	24" (600mm)	A	6" FLG
HD5670B2-1		268	615	340	30" (750mm)	B	
HD5672B2-1		300	690	355	36" (900mm)	C	
HD5673B2-1		363	810	375	42" (1000mm)	D	
HD5674B2-1		426	930	395	48" (1200mm)	E	
HD5675B2-1		489	1050	415	60" (1500mm)	F	
HD5676B2-1		552	1170	430	63-80" (1600-2000mm)	G	

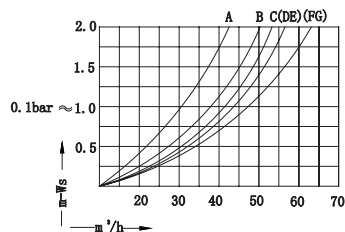
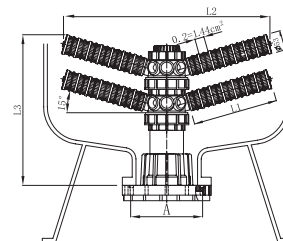

型号 Type	尺寸 Dimension(mm)				罐体尺寸 Tank Size Inches(mm)	流量 Flow	罐体上开口 Top Opening
	A	L1	L2	L3			
HD5669B2-2	89/90/110 /114 3" NPT/3" BSPT 4" NPT/4" BSPT 4" UN	205	490	450	24" (600mm)	A	6" FLG
HD5670B2-2		268	615	460	30" (750mm)	B	
HD5672B2-2		300	690	465	36" (900mm)	C	
HD5673B2-2		363	810	475	42" (1000mm)	D	
HD5674B2-2		426	930	485	48" (1200mm)	E	
HD5675B2-2		489	1050	495	60" (1500mm)	F	
HD5676B2-2		552	1170	510	63-80" (1600-2000mm)	G	

备注：流量加大，法兰开口尺寸请选择4"  
 If large flow rate, you'd better choose 4" interface.

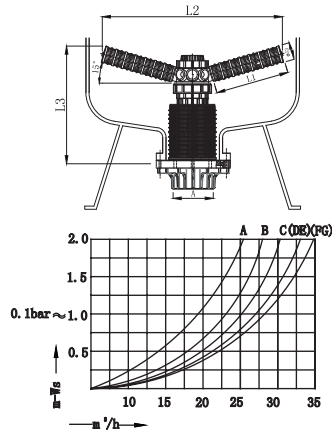

型号 Type	尺寸 Dimension(mm)				罐体尺寸 Tank Size Inches(mm)	流量 Flow	罐体上开口 Top Opening
	A	L1	L2	L3			
HD5669D2-1	89/90/110/114 3" NPT/3" BSPT 4" NPT/4" BSPT 4" UN	205	490	320	24" (600mm)	A	6" FLG
HD5670D2-1		268	615	340	30" (750mm)	B	
HD5672D2-1		300	690	355	36" (900mm)	C	
HD5673D2-1		363	810	375	42" (1000mm)	D	
HD5674D2-1		426	930	395	48" (1200mm)	E	
HD5675D2-1		489	1050	415	60" (1500mm)	F	
HD5676D2-1		552	1170	430	63-80" (1600-2000mm)	G	

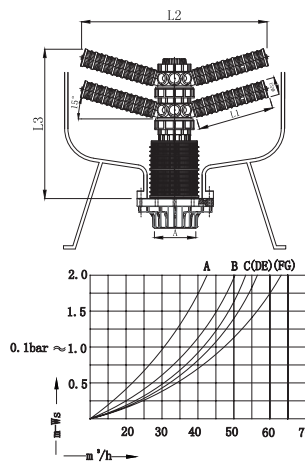

型号 Type	尺寸 Dimension(mm)				罐体尺寸 Tank Size Inches(mm)	流量 Flow	罐体上开口 Top Opening
	A	L1	L2	L3			
HD5669D2-2	89/90/110/114 3" NPT/3" BSPT 4" NPT/4" BSPT 4" UN	205	490	450	24" (600mm)	A	6" FLG
HD5670D2-2		268	615	460	30" (750mm)	B	
HD5672D2-2		300	690	465	36" (900mm)	C	
HD5673D2-2		363	810	475	42" (1000mm)	D	
HD5674D2-2		426	930	485	48" (1200mm)	E	
HD5675D2-2		489	1050	495	60" (1500mm)	F	
HD5676D2-2		552	1170	510	63-80" (1600-2000mm)	G	

备注：流量加大，法兰开口尺寸请选择4"  
If large flow rate, you'd better choose 4" interface.

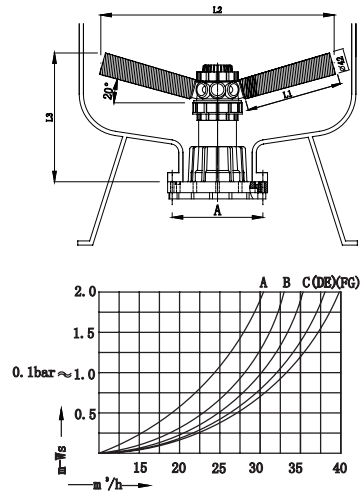

型号 Type	尺寸 Dimension (mm)				罐体尺寸 Tank Size	流量 Flow	绕丝管缝隙 Slot (mm)	罐体下开口 Bottom Opening
	A	L1	L2	L3	Inches (mm)			
HD5669C-1	110 4" NPT/4" BSPT 4" UN	205	490	320	24" ( 600mm)	A	0.2/0.25/	6"FLG
HD5670C-1		268	615	340	30" ( 750mm)	B	0.3/0.35/	
HD5672C-1		300	690	355	36" ( 900mm)	C	0.4/0.45/	
HD5673C-1		363	810	375	42" ( 1000mm)	D	0.5/	
HD5674C-1		426	930	395	48" ( 1200mm)	E	.....	
HD5675C-1		489	1050	415	60" ( 1500mm)	F	任意缝隙可选	
HD5676C-1		552	1170	430	63-80" ( 1600-2000mm)	G		

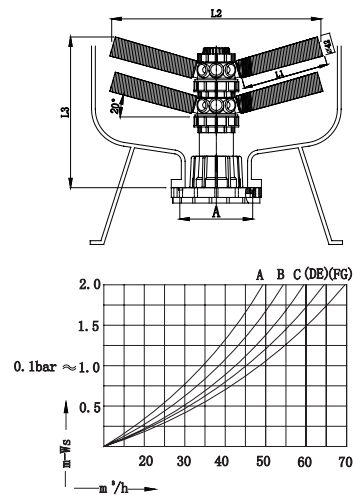

型号 Type	尺寸 Dimension (mm)				罐体尺寸 Tank Size	流量 Flow	绕丝管缝隙 Slot (mm)	罐体下开口 Bottom Opening
	A	L1	L2	L3	Inches (mm)			
HD5669C-2	110 4" NPT/4" BSPT 4" UN	205	490	450	24" ( 600mm)	A	0.2/0.25/	6"FLG
HD5670C-2		268	615	460	30" ( 750mm)	B	0.3/0.35/	
HD5672C-2		300	690	465	36" ( 900mm)	C	0.4/0.45/	
HD5673C-2		363	810	475	42" ( 1000mm)	D	0.5/	
HD5674C-2		426	930	485	48" ( 1200mm)	E	.....	
HD5675C-2		489	1050	495	60" ( 1500mm)	F	任意缝隙可选	
HD5676C-2		552	1170	510	63-80" ( 1600-2000mm)	G		

备注：流量加大，法兰开口尺寸请选择4"  
If large flow rate, you'd better choose 4" interface.

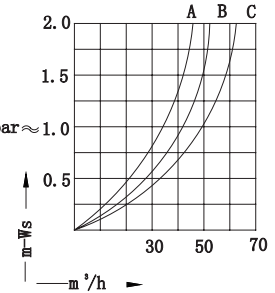
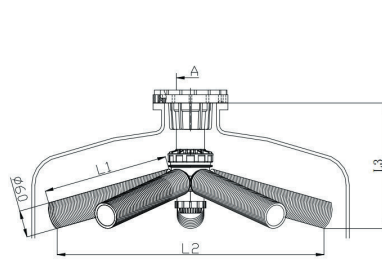

型号 Type	尺寸 Dimension (mm)				罐体尺寸 Tank Size Inches (mm)	流量 Flow	绕丝管缝隙 Slot (mm)	罐体上/下开口 Top/Bottom Opening
	A	L1	L2	L3				
HD5651-1	110 4" NPT/4" BSPT 4" UN	552	1170	500	60"-63"(1500-1600mm)	A	0.2/0.25/ 0.3/0.35/ 0.4/0.45/ 0.5/ ..... 任意缝隙可选	6"FLG
HD5652-1		615	1290	515	72"-80"(1800-2000mm)	B		

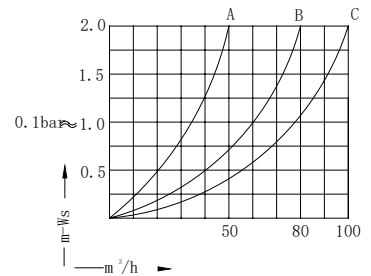
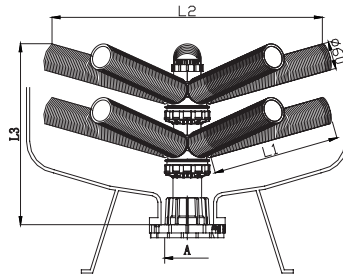

型号 Type	尺寸 Dimension (mm)				罐体尺寸 Tank Size Inches (mm)	流量 Flow	绕丝管缝隙 Slot (mm)	罐体下开口 Bottom Opening
	A	L1	L2	L3				
HD5651-2	110 4" NPT/4" BSPT 4" UN	552	1170	650	60"-63"(1500-1600mm)	A	0.2/0.25/ 0.3/0.35/ 0.4/0.45/ 0.5/ ..... 任意缝隙可选	6"FLG
HD5652-2		615	1290	665	72"-80"(1800-2000mm)	B		

备注：流量加大，法兰开口尺寸请选择4"  
If large flow rate, you'd better choose 4" interface.



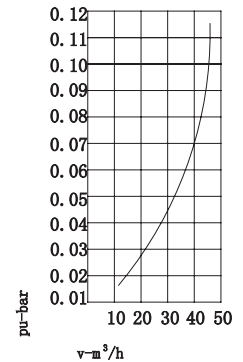
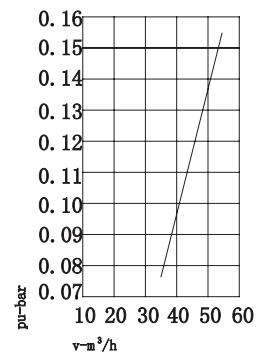
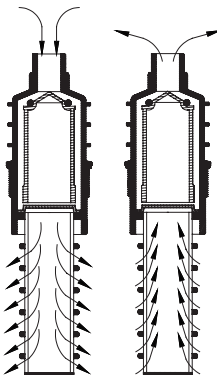
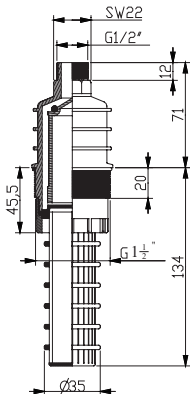
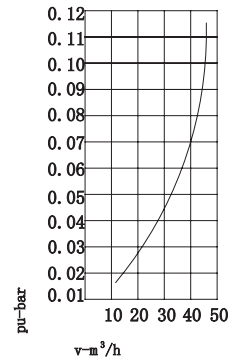
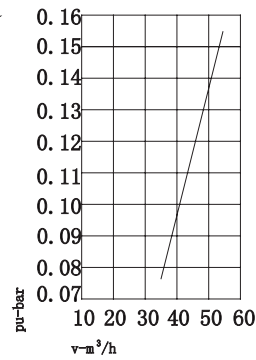
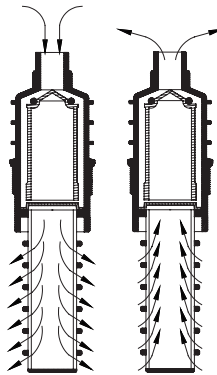
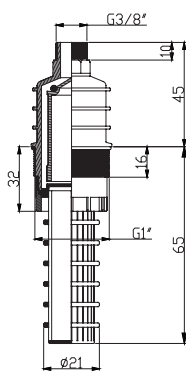
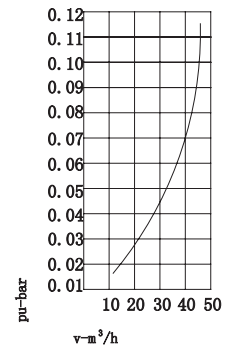
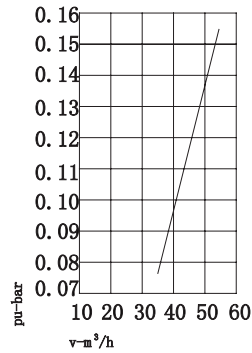
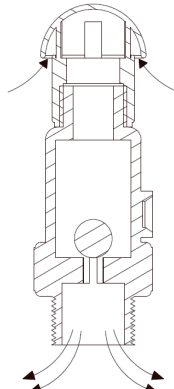
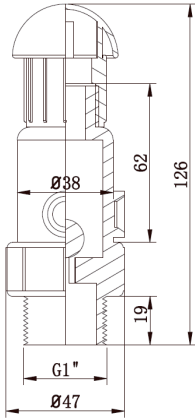
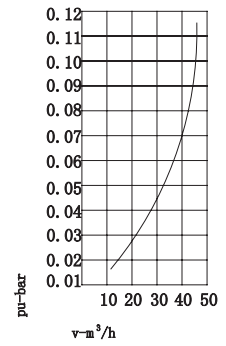
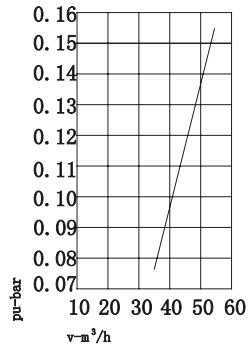
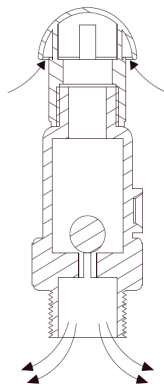
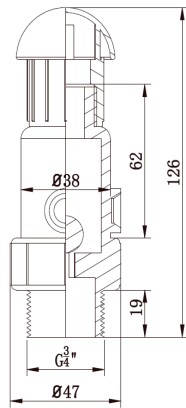

VN-3

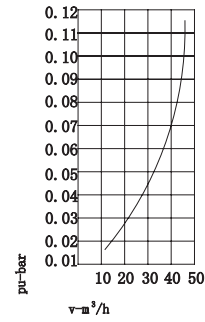
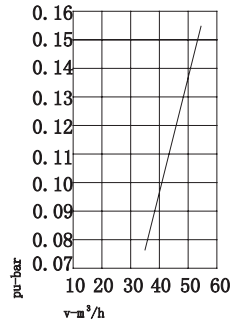
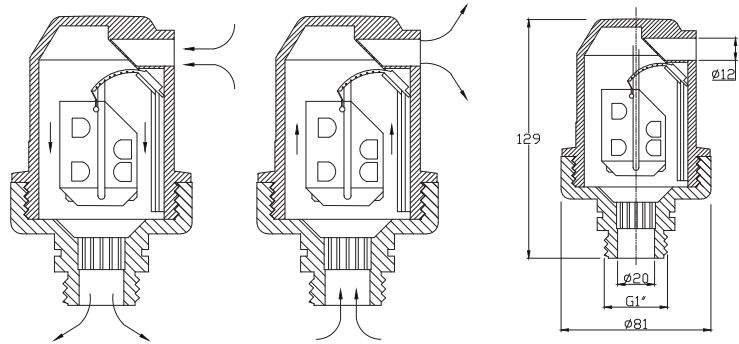

VN-4

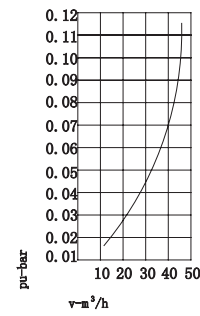
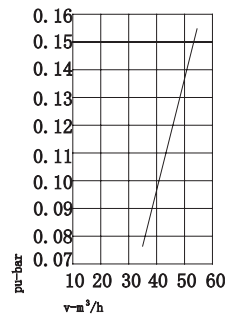
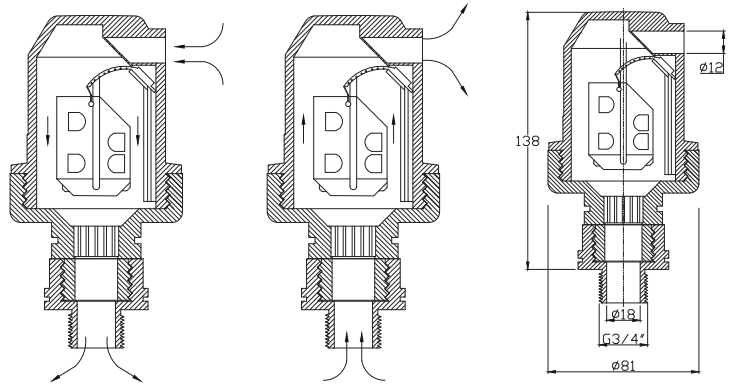

**黑二通系列 Tank Head Series**
**H9901**

**H9902**

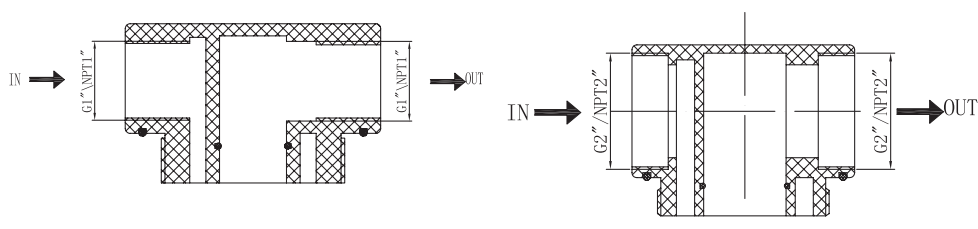
**H9902-1**

型号 (Type)	名称 (Name)	材质 (Material)	罐体开口 (Tank opening)	接口尺寸 (In/Out)	中心管径 (Center Riser)
H9901	2.5"黑二通 (2.5"tank head)	UPVC	2.5"-8NPSM	G1"/NPT1"/G $\frac{3}{8}$ "/NPT $\frac{3}{8}$ "	3/4"(27mm)/1"(33.4mm)
H9902	4"黑二通 (4"tank head)	UPVC	4"-8UN	G2"/NPT2"	1.5"(48.3/50 mm)
H9902-1	4.5"黑二通及上下布水器 (4.5"tank head & distributor)	ABS	4.5"Buttress	NPT1"	1"(33.4mm)

**变径系列 Adaptor Series**
**Type:H9903-A**

**Type:H9903-B**

**Type:H9904**

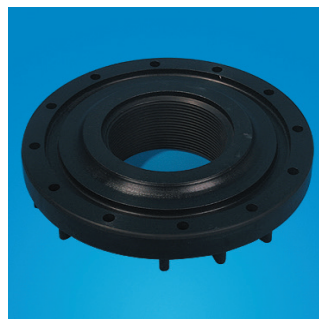
**Type:H9905**

型号 (Type)	名称 (Name)	材质 (Material)	外螺纹 (Outer Thread)	内螺纹 (Inner Thread)
H9903-A	4"-2.5" 变径 (4-2.5"Adaptor)	ABS	4"-8UN	2.5"-8NPSM
H9903-B	4"-2.5"变径 (4-2.5"Adaptor)	ABS/PPO	4"-8UN	2.5"-8NPSM
H9904	6"-4" 变径 (6-4"Adaptor)	ABS/PPO	6"-8UN	4"-8UN
H9905	6"-4" 法兰变径 (6-4" FLG Adaptor)	PVC/PPO		4"-8UN 4"-8NPT

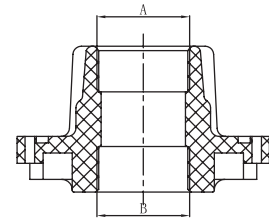
**闷盖、法兰系列 Closure & Flange Series**
**H9914-A**
**H9914-B**
**H9913**
**H9910-H9912**

型号 (Type)	名称 (Name)	材质 (Material)	外螺纹 (Outer Thread)
H9914 -A	4" 闷盖 (4" Closure)	ABS/PPO	4"-8UN
H9914 -B	4" 闷盖 (4" Closure)	ABS/PPO	4"-8UN
H9913	6" 法兰闷盖 (6" FLG Closure)	PVC/PPO	

型号(Type)	名称 (Name)	螺纹 A (Thread A)	螺纹 B (Thread B)	材质 (Material)
H9910	6" 法兰座	3"BSPP/3"NPT	89/90	PVC /PPO
H9911	6" 法兰座	3"BSPP/3"NPT	4" UN /4"NPT	PVC /PPO
H9912	6" 法兰座	3"BSPP/3"NPT	3"BSPP/3"NPT	PVC /PPO

**树脂捕捉器 Resign Trap**

Type (型号)	Connection (接口形式)
RT-1	2" or 3" glue(粘结)
RT-2	2" or 3" union (活结)
RT-3	2" or 3" flange (法兰)

## 盐阀系列 Brine Valve Series

所有盐阀均经过高压测试

H9906

H9907

H9908

H9909

H9909-1

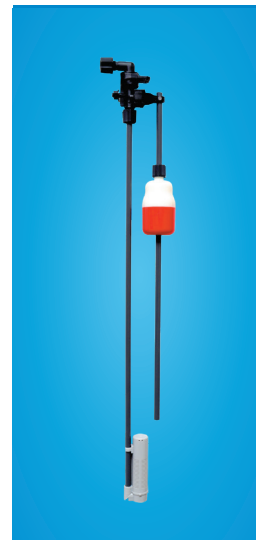
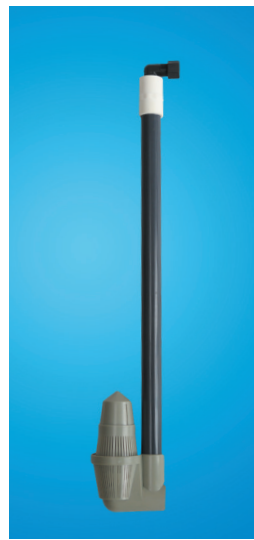
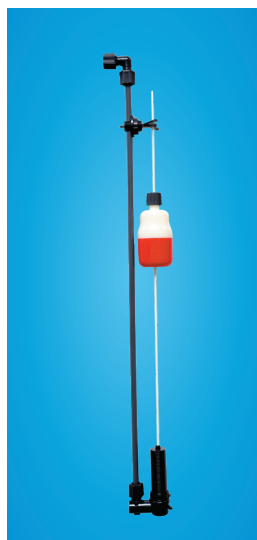
 454盐阀  
454Brine Valve

 434盐阀  
434Brine Valve

 1700盐阀  
1700Brine Valve

 1600盐阀  
1600Brine Valve

 1600逆止阀  
1600Air Check Valve

备注 (Remark) :

液位保护和空气逆止功能 (liquid level protection &amp; air check function): H9906, H9907, H9909

仅空气逆止功能 (only air check function): H9908, H9909-1

H9907, H9909, H9909-1 接口尺寸- 接软管connect size-hose: 3/8"

H9906, H9908 接口尺寸- 接软管connect size-hose: 1/2"

H9906, H9908 接口尺寸- 接硬管connect size-PVC tube: 3/4" (25mm or 26.7mm)

盐阀高度可根据盐箱尺寸定制

## 盐箱系列 Brine tank

型号 Type	容积 Capacity	箱体尺寸 Dimension(mm)-Diameter*Height(inside)*Height(outside)
HX-15	15L	φ 210*420*460
HX-25	25L	φ 240*460*500
HX-60	60L	φ 340*630*700
HX-100	100L	φ 390*790*850
HX-150	150L	φ 500*820*880
HX-200	200L	φ 500*940*1020
HX-300	300L	φ 640*1070*1200
HX-500	500L	φ 780*1150*1310
HX-800	800L	φ 910*1170*1350
HX-1000	1000L	φ 1040*1220*1400
HX-1500	1500L	φ 1400*1120*1310
HX-2000	2000L	φ 1400*1420*1600
HX-3000	3000L	φ 1400*2150*2300



## Panel flowmeters

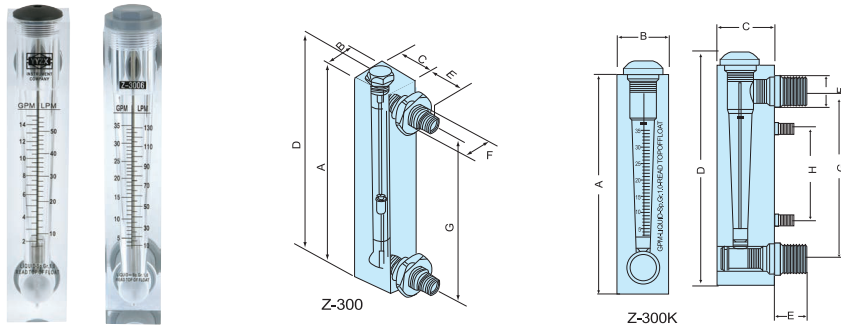

Type	Measure Range		Thread	A	B	C	D	E	F	G	H
	GPM	LPM									
Z-3000	0.03~0.35	0.1~1.4	BSP1/2"	206	34	40	215	31	20	165	/
Z-3001	0.2~2	1~7									
Z-3002	0.5~5	1.8~18									
Z-3003	2~10	5~40									
Z-3004	2~16	10~60									
Z-3005	4~24	20~100									
Z-3006	5~35	30~130	BSP1"	240	44	50	253	47	33	175	/
Z-300K1	0.1~1	0.5~4									
Z-300K2	0.2~2	1~7									
Z-300K2a	0.3~3	2~11									
Z-300K3	0.5~5	2~18									
Z-300K4	1~10	5~35									
Z-300K5	2~14	10~50									
Z-300K6	2~20	10~70	ZG1"	226	45	46	232	48	33	165	100
Z-300K7	5~35	10~130									

## Pipeline flowmeters

Type	Measure Range		Thread (F/BSP)	A	B	C	D	E	F	G	H
	GPM	LPM									
Z-4001	0.2~2	1~7	1/2"	210	32	Joint(PP)or1 Cr18Ni9Ti(304ss)	O-ring(Silicon, Fluoro, Nitrile)	Blocking ring(ABS, Nylon)	Float(1 Cr18Ni9Ti, 304ss)	Guide rod(316ss)	Body(PMMA)
Z-4002	0.5~5	1.8~18									
Z-4003	1~10	4~36	3/4"	278	45						
Z-4004	2~20	10~70	1"	265	51						
Z-4005	5~30	20~110									
Z-4006	20~60	80~220	1 1/2" Male	306	51						
Z-4007	30~110	100~400	2"	345	75						
Z-4008	50~150	180~600									
Z-4009	60~200	200~800									

- Working pressure limited:  $\leq 0.6\text{MPa}$ (6Bar)
- Working temperature limited: 0-55°C
- Accuracy:  $\pm 5\%$

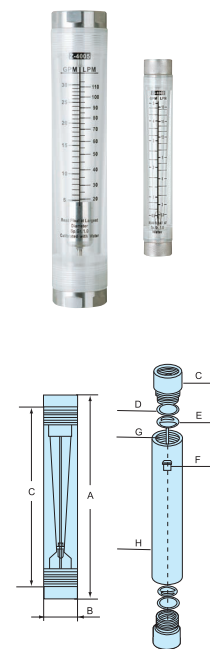

## Plastic flowmeters

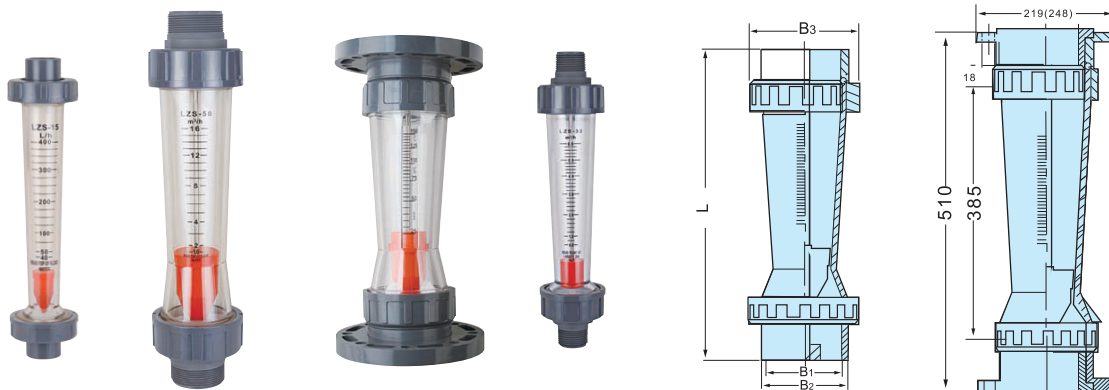

Type	Measuring range	Glue	Male	Female	L	B1	B2	B3
	M <sup>3</sup> /H							
LZS-15	10~100 L/H	∅20	NPT 1/2" NPT 3/4"	BSP 1/2"	220	20	26	51
	16~160 L/H							
	25~250 L/H							
	40~400 L/H							
	60~600 L/H							
100~1000 L/H								
LZS-25	0.1~1	∅32	NPT 3/4"	BSP 3/4" NPT 3/4"	230	32	39	60
	0.16~1.6							
	0.25~2.5							
LZS-32	0.4~4	∅40	NPT 1"	BSP 1" NPT 1"	290	40	49	72
	0.6~6							
LZS-50	0.4~4	∅63	NPT 2"	BSP 2" NPT 2"	350	63	73	98
	0.6~6							
	1~10							
	1.6~16							
LZS-65	5~25	∅75	/	NPT 2 1/2"	420	75	88	122
	8~40							
	12~60							
LZS-100 flange	12~60	∅110	Hole distance 1180mm Hole ∅8-∅18		547	/	/	/
	18~90							
	20~120							
LZS-125 flange	25~150	∅110	Hole distance 1210mm Hole ∅8-∅18		547	/	/	/
	30~180							
LZS-150 flange	12~60	∅110	Hole distance 1240mm Hole ∅8-∅22		547	/	/	/
	18~90							
	20~120							
	25~150							
	30~180							

LZS Series main parts: tube SAN, float ABS, glue fitting, PVC male thread PA6, female thread PA66

•Working pressure limited:  $\leq 0.6\text{MPa}$ (6Bar) •Working temperature limited: 0-60°C •Accuracy:  $\pm 5\%$



## 湖州恒鑫过滤科技有限公司

HuZhou HengXin Filter Technology Co., Ltd

地址：浙江省湖州市八里店工业园区

(Add): Balidian Industrial Zone, Huzhou, Zhejiang, China

电话 (Tel): 86-572-2812276 (国内销售)

86-572-2812278 (foreign trade department)

传真 (Fax): 86-572-2812277

网址: <http://www.hxplastics.com> (国内销售)

<http://www.hengxinfilter.com> (foreign trade department)

E-mail: [info@hxplastics.com](mailto:info@hxplastics.com) (国内销售)

[jessica@hxplastics.com](mailto:jessica@hxplastics.com) (foreign trade department)



企业微信公众号